



UNIVERSITY OF RUHUNA

Faculty of Engineering

End-Semester 4 Examination in Engineering: February 2020

Module Number: CE4301

Module Name: Design of Concrete Structures I

[Three Hours]

[Answer all questions, all questions carry twelve marks each.]

BS 8110 Part I: [1997] is provided

(All symbols used in the paper have their usual meaning unless otherwise stated)

- Q1. a) Rectangular beam 250 mm × 500 mm (see Fig. Q1 (a)) with an effective depth (d) of 452.5 mm is reinforced with five numbers of 25mm diameter high yield steel bars at the bottom and 02 Nos. of 20 mm diameter high yield steel bars at the top. Take $f_{cu} = 30 \text{ N/mm}^2$, $f_y = 500 \text{ N/mm}^2$ and $E_s = 200 \text{ kN/mm}^2$ and calculate the sagging moment carrying capacity of the section. Assume effective depth to top reinforcement (d') equals to 47.5 mm. [5 Marks]
- b) Consider that composite concrete slab of 125mm is cast at the top of the beam described in the Q1. a) above and that 950 mm slab width of the slab is effectively contributing to the beam flange action as shown in Fig Q1 (b) when the beam is subjected to sagging moment.
- i) Calculate the new sagging moment capacity of the section considering the flange action of the slab. [4 Marks]
- ii) Calculate the reinforcement requirement to support the moment capacity found in Q1 (b) i) without the flange action (i.e. considering section as rectangular beam 250 mm wide and 500 mm deep). [3 Marks]
- Q2. a) All edges continuous 5 m × 6 m internal slab panel extracted from a sufficiently large slab is shown in the Fig. Q2. Slab is expected to support 5 kN/m² imposed load, self-weight of the deck and load from finishes amounting to 1 kN/m². Take density of concrete as 24 kN/m³ and calculate the critical moments at the continuous and discontinuous edges and in the mid-way of the slab panel. Take the thickness of the slab as 150 mm and consider load from finishes as dead load. [4 Marks]
- b) Calculate the critical reinforcement requirement at the beam supports and at the middle of the slab panel based on requirement to resist applied bending moment, control crack width, deflection, and satisfy the minimum reinforcement requirement. Take cover to all reinforcement in the major direction of bending as 20mm, $f_{cu} = 30 \text{ N/mm}^2$, $f_y = 500 \text{ N/mm}^2$, and the slab is reinforced with 10 mm diameter high yield steel bars. [4 Marks]
- c) Calculate and show whether adequate shear resistance is provided by the selected slab thickness. [2 Marks]
- d) Draw the reinforcement details of the slab panel. [2 Marks]

- Q3 a) Elastic bending moment diagrams for the continuous beam ABCD shown in Fig. Q3 a) i) for the critical load combinations described in BS 8110 are shown in Fig. Q3 a) ii), Fig. Q3 a) iii) and Fig. Q3 a) iv). Calculate main reinforcement requirement of the beam based on elastic bending moment diagram. Take $f_{cu} = 30 \text{ N/mm}^2$, $f_y = 500 \text{ N/mm}^2$, cross sectional dimension of the beam as $250 \times 550 \text{ mm}$, and the effective depth to tension reinforcement (d) and compression reinforcement (d') as 502.5 mm and 47.5 mm respectively.

[5Marks]

- b) Shear force diagrams for the same beam ABCD shown in Fig.3 a) i) for the critical load combinations described in BS8110 are shown in Fig. Q3 b) i), Fig. Q3 b) ii) and Fig. Q3 b) iii). Propose a shear reinforcement arrangement for the beam ABCD assuming 8 mm mild steel as shear reinforcement. Take $f_{cu} = 30 \text{ N/mm}^2$, $f_{yv} = 250 \text{ N/mm}^2$, cross sectional dimension of the beam as $250 \times 550 \text{ mm}$, and the effective depth to tension reinforcement (d) and compression reinforcement (d') as 502.5 mm and 47.5 mm respectively.

[3 Marks]

- c) Check serviceability limit state cracking and deflection performance of the beam ABCD based on deemed to satisfy conditions and propose the final reinforcement arrangement for the beam.

[2 Marks]

- d) Provide the reinforcement detail for the beam based on answers above showing clearly lap length and anchorage length requirements. (Use separate graph sheet for the reinforcement detail)

[2 Marks]

- Q4 Plan view, and two cross sections of a ground floor column located in a braced structure is shown in Fig Q4 (a). Column is connected to a moment carrying based at the bottom and monolithically cast beams and slab at the first floor level. The cross section dimensions of the beams connected at the first floor level are $250 \text{ mm} \times 400 \text{ mm}$ and the slab has a 125 mm thickness. From the frame analysis it is found that the column is subjected to axial load and bending moment about its major axis as shown in the Table Q4 below. Column is rectangular section with dimensions of $400 \text{ mm} \times 300 \text{ mm}$. The height of the column from top of foundation to the top of the first floor level is 8.5 m .

Table Q4. Loading details of the column

Axial Load	Moment about major axis (kNm)		Moment about minor axis (kNm)	
	X-X Axis (Major axis of bending)		Y-Y Axis (Major axis of bending)	
	Top	Bottom	Top	Bottom
1800 kN	120	- 80	80	-60

- a) Calculate the effective length of the column about the major and minor axis and determine its classification in accordance with the provisions of BS 8110.

[2 Marks]

- b) Based on above classification, applied load and applied initial bending moment, calculate the reinforcement detail for the above column located in the ground floor level. Take concrete grade as G40 (40 N/mm^2), reinforcement grade as 460 (460 N/mm^2) and assume d/h of the column as 0.9 . The relevant column interaction diagram is given in the Fig. Q4 (b).

[8 Marks]

- c) Explain how the calculations would have been changed had the frame been considered was un-brazed.

[2 Marks]

Q5. An internal column 400 mm×300 mm carries un-factored dead load of 900 kN and an un-factored imposed load of 500 kN. The ground where the structure is expected to be constructed is estimated to have a bearing capacity of 200 kN/m².

- a) Considering, that the column will be supported by an individual footing, and the connection between column and footing idealized as pinned, select suitable square dimension for the column foundation and a thickness for the footing.
(Hint: Initial trial depth (d) for the footing shall be based on $d = 10.5 N^{0.5}$ where d is in mm N (axial load) is in kN.)

[2 Marks]

- b) Based on the selected foundation detail above, calculate the reinforcement detail for the above foundation based on the bending moment requirement at the critical section. Assume grade 30 concrete and grade 500 high yield steel for construction. Take cover to all reinforcement as 50 mm.

[4 Marks]

- c) Calculate the line shear and punching shear resistance of the pad and check whether the required resistances are provided by the selected dimensions of the foundation in the Q5 a) above.

[5 Marks]

- d) Draw the reinforcement detail for the footing

[1 Mark]

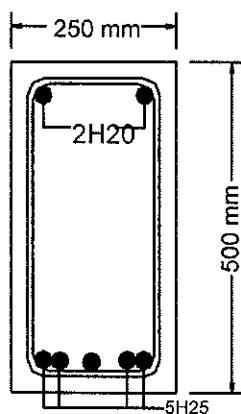

Fig. Q1 a) Rectangular section

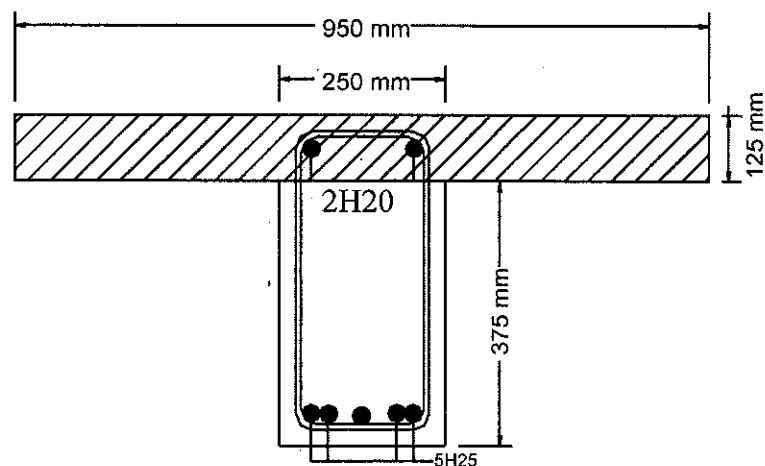

Fig. Q1 b) Flange section

Fig. Q1 Rectangular and flange beam section

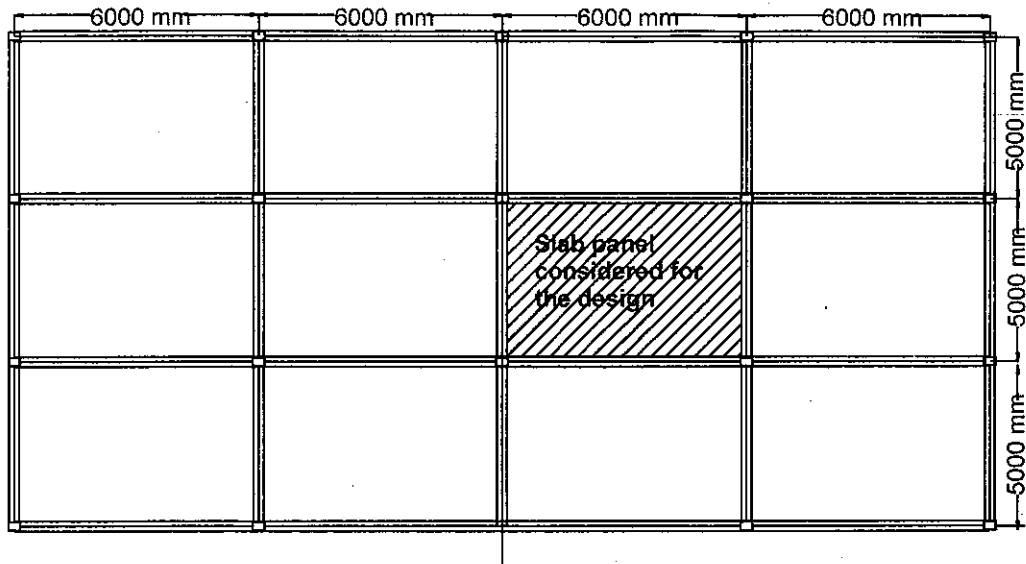

Fig. Q2 Middle slab panel with all the adjacent edges continuous.

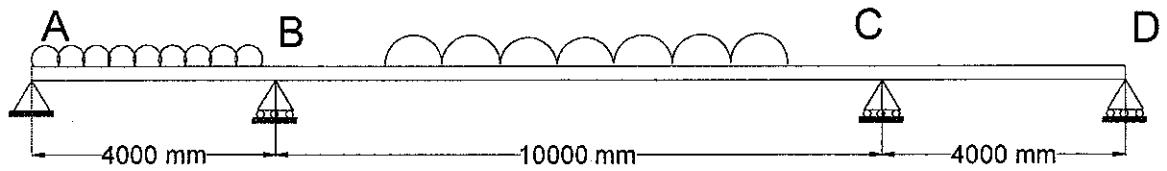

Fig. Q3 a) i) Continuous beam with three spans

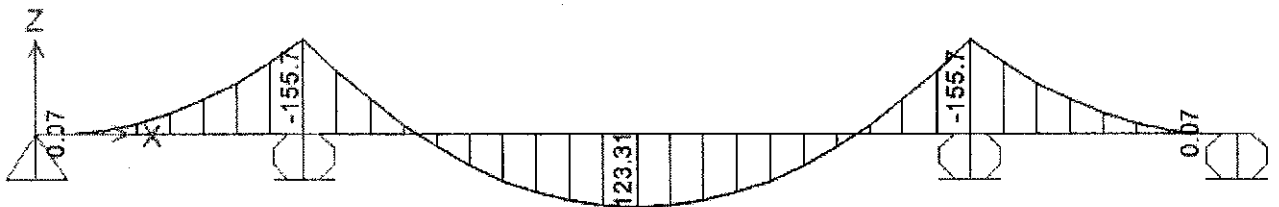

Fig. Q3 a) ii) Case 1: All spans fully loaded

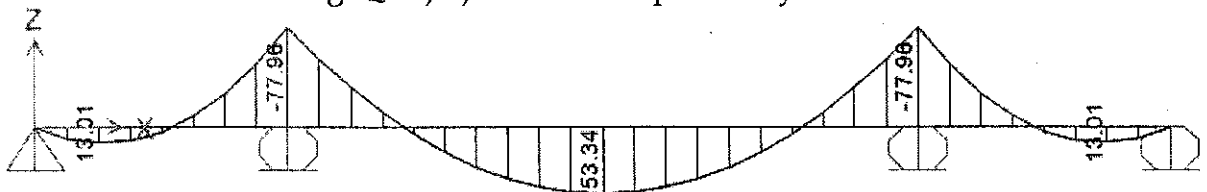

Fig. Q3 a) iii) Case 2: Alternative spans fully loaded maximum loading in the edge two edges

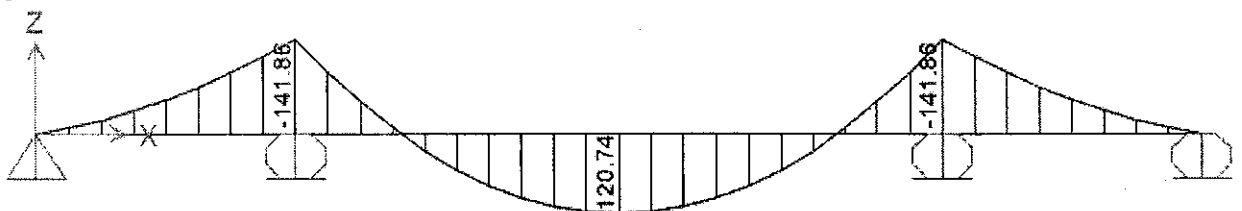

Fig. Q3 a) iv) Case 3: Alternative spans fully loaded maximum loading in the middle span

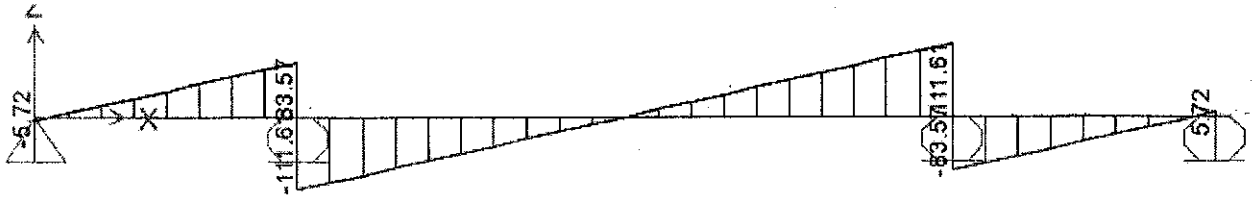

Fig. Q3 b) ii) Case 1: All spans fully loaded

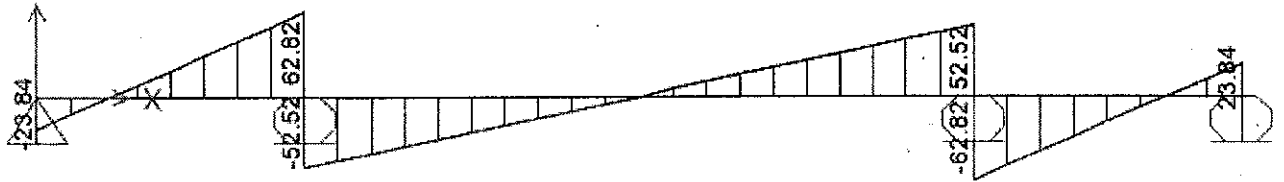

Fig. Q3 b) iii) Case 2: Alternative spans fully loaded maximum loading at the two edges

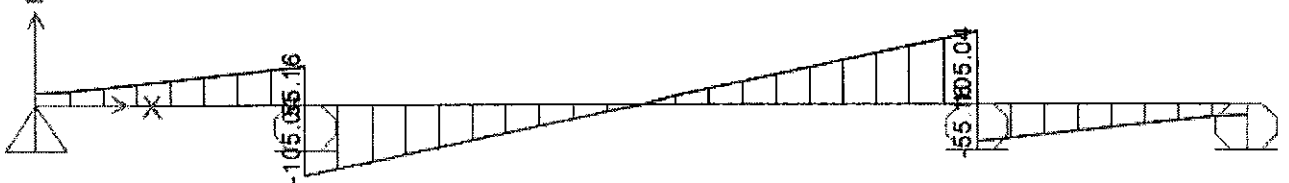
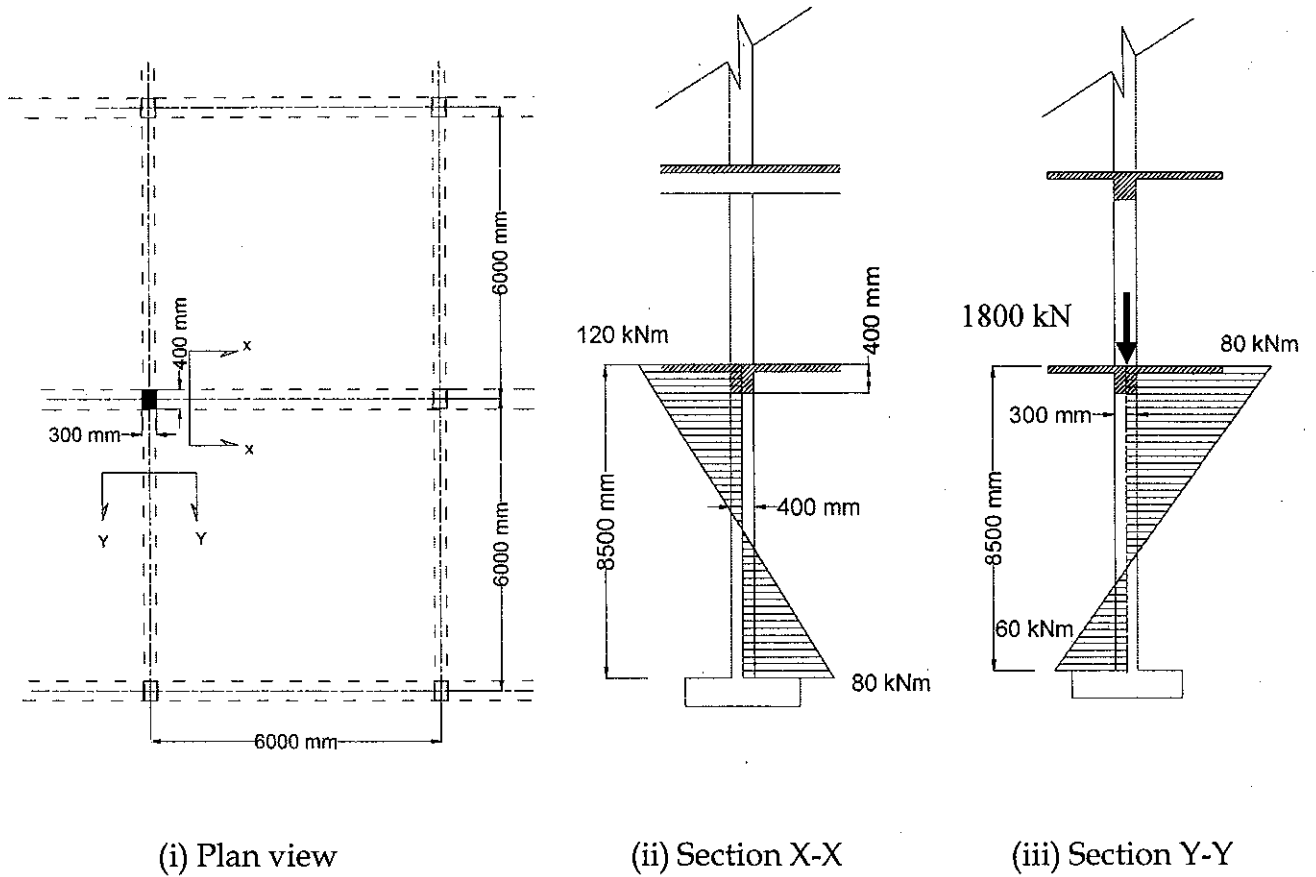

Fig. Q3 a) iv) Case 3: Alternative spans fully loaded maximum loading in the middle span



(i) Plan view

(ii) Section X-X

(iii) Section Y-Y

Fig. Q4 (a) Plan view and cross sections of the ground floor column

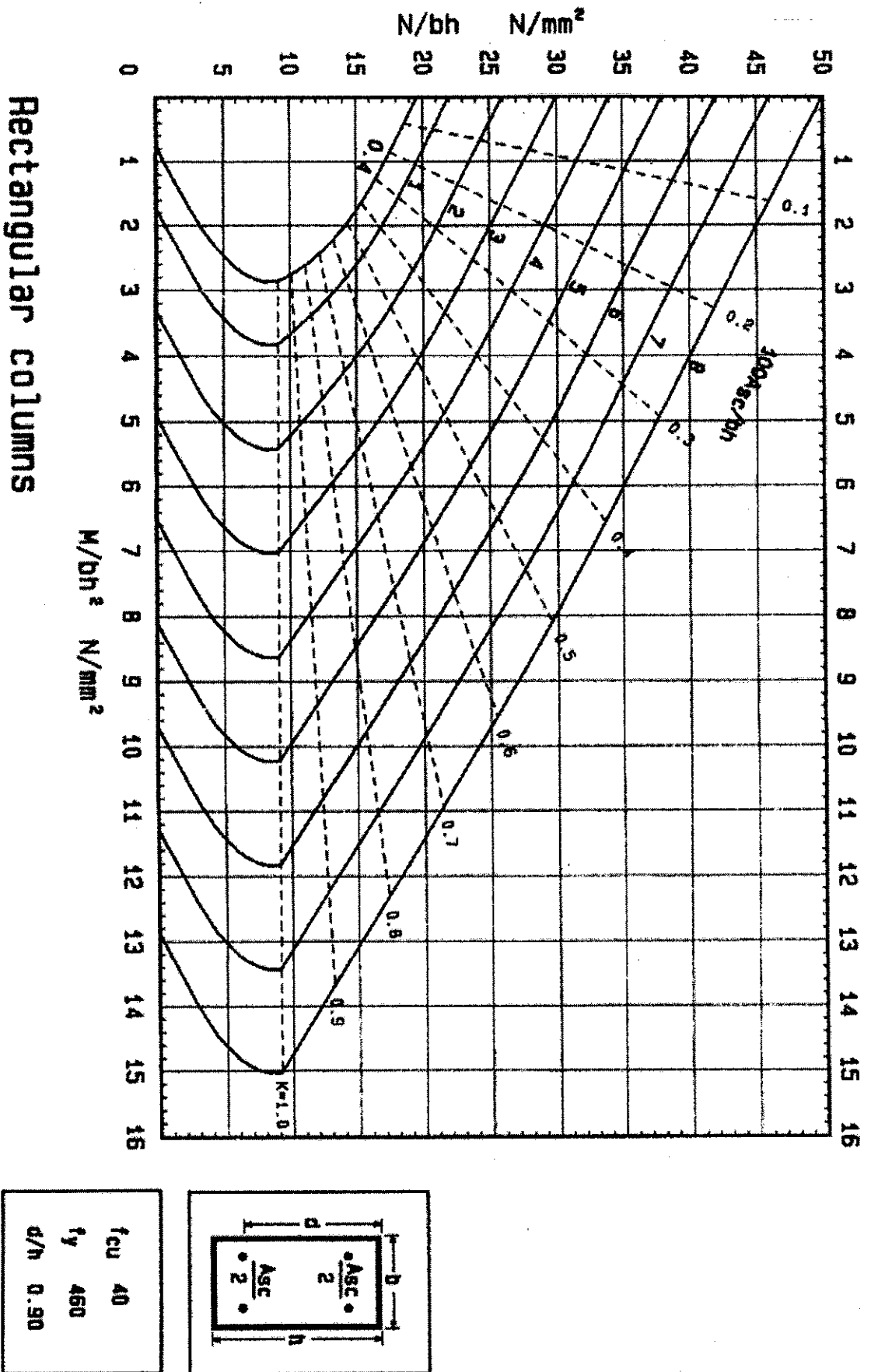

Fig. Q4 b) Relevant column interaction diagram