



UNIVERSITY OF RUHUNA

Faculty of Engineering

End-Semester 3 Examination in Engineering: August 2015

Module Number: EE3301

Module Name: Analog Electronics

[Three Hours]

[Answer all questions, each questions carries 10 marks each]

All notations have their usual meanings.

Q1

- a) Justify that the constant current source I in the circuit in Figure Q1 a) is mirrored to the collector current of transistor T2. Assume that T1 and T2 are matched. [2 Marks]
- b) i) Reproduce the circuit of an ideal differential amplifier that has collector bias resistors R_c , bias voltage $+V_{cc}$ and a constant current source I .
ii) Perform the DC analysis of the circuit and derive expressions for the DC output voltages.
iii) Show that the transistor internal ac emitter resistance $r_e = 0.052/I$
iv) If one input to the circuit is grounded and a $20 \sin(\omega t)$ mV signal is present at the other input, predict the values of the outputs for $R_c = 6 \text{ k}\Omega$ and $I = 2 \text{ mA}$.
v) Predict the voltages at the emitter terminals of the transistors for this case? [6.5 Marks]
- c) Figure Q1 b) shows the circuit of a constant current source for a differential amplifier. Calculate the current in the collector of the transistor. [1.5 Marks]

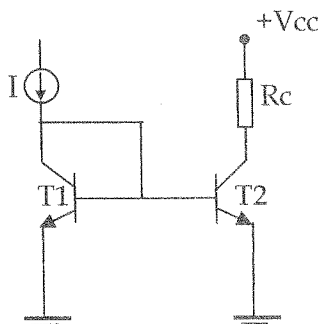

Figure Q1 a)

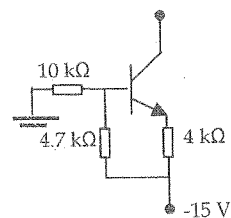

Figure Q1 b)

Q2

- a) Define the properties of an ideal operational amplifier [0.5 Marks]
- b) Figure Q2 shows a non-inverting operational amplifier circuit.
i) Formulate an expression for the voltage gain of the circuit.
ii) State an advantage of this amplifier circuit.
iii) Design a block diagram that demonstrate the feedback process in this circuit and formulate an expression for the feedback ratio β . [3.5 Marks]
- c) i) Sketch the desired typical frequency response of the open loop gain of an operational amplifier and denote its characteristic features.
ii) Define the Gain Bandwidth Product (GBP).
iii) Define the closed loop gain bandwidth in terms of the GBP.
iv) Compute the minimum slew rate for an amplifier with a gain of 10 to amplify a ramp voltage that changes from -1 V to 2 V in 20 μ s. [4 Marks]
- d) In the operational amplifier circuit with feedback as shown in Figure Q2, a resistor R_c can be connected in series with the non-inverting input in order to minimize the input offset current. Derive an expression for the value of R_c . [2 Marks]

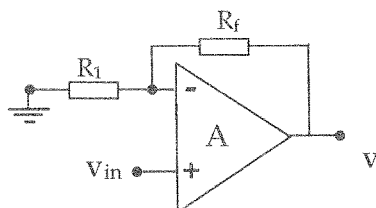

Figure Q2

Q3

- a) i) Draw an operational amplifier based ideal integrator circuit and demonstrate the integration process.
ii) For a sinusoidal input, demonstrate that the ideal integrator frequency characteristic is similar to that of a low-pass filter.
iii) Synthesize a circuit to perform the mathematical function

$$v_0 = 2(v_1 - v_2)$$

[5 Marks]

b) Figure Q3 I) and Figure Q3 II) shows two operational amplifier based circuits.

- i) Name the circuits.
- ii) Define the feedback ratios for the two circuits.
- iii) Explain why there is no external input to the circuit in Figure Q3 II).
- iv) Sketch the input/output voltage characteristics for the two circuits.

[5 Marks]

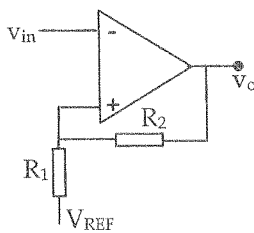

Figure Q3 I)

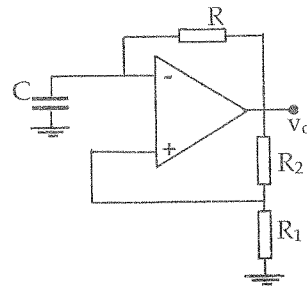

Figure Q3 II)

Q4

- a) i) Explain what is meant by an electronic oscillator.
- ii) What is a square wave oscillator normally called?
- iii) Draw a block diagram of an oscillator and state the Barkhausen criterion for a system to oscillate.

[2 Marks]

b) The frequency of oscillation of a Colpitt's oscillator is given by,

$$f_0 = \frac{1}{2\pi \left\{ L \left[\frac{C_1 C_2}{C_1 + C_2} \right] \right\}^{1/2}}$$

where L, C₁ and C₂ are the frequency determining components.

This circuit operates at 450 kHz with C₁ = C₂. What will be the oscillation frequency if the value of C₂ is doubled?

[2 Marks]

c) The transfer function equation of a second order band pass filter is given by

$$H(j\omega) = \frac{K}{1 + jQ(\omega/\omega_0 - \omega_0/\omega)}$$

Starting with the equation for the transfer function, formulate the following equations for the lower and upper cut-off frequencies.

$$\omega_l = \omega_0 \sqrt{1 + \frac{1}{4Q^2} - \frac{\omega_0}{2Q}}$$

$$\omega_u = \omega_0 \sqrt{1 + \frac{1}{4Q^2} + \frac{\omega_0}{2Q}}$$

[3 Marks]

d) The RLC circuit shown in Figure Q4 is a second order band pass filter.

- i) State the transfer function for the RLC band pass filter.
- ii) Formulate expressions for the center frequency and the Q (quality factor).
- iii) Determine the center frequency ω_0 and the Q for a RLC band pass filter that has a lower cut-off frequency of 1 kHz and a bandwidth of 3 kHz?

[3 Marks]

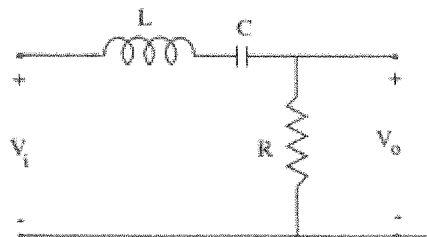

Figure Q4

Q5

- a) i) Draw the circuit of an n-channel JFET to be biased for normal operation.
- ii) Reproduce the n-channel JFET Drain and Transfer characteristics and indicate all the regions of the curve.

[3 Marks]

- b) i) Define Transconductance for a JFET.
 ii) Prove the following equations for Transconductance.

$$g_m = g_{m0} \sqrt{\frac{I_D}{I_{DSS}}}$$

$$g_{m0} = \frac{-2I_{DSS}}{V_{GS(off)}}$$

$$\text{Hint: } I_D = I_{DSS} \left[1 - \frac{V_{GS}}{V_{GS(off)}} \right]^2$$

[3 Marks]

- c) i) State three FET biasing mechanisms and draw the voltage divider biasing circuit.

- ii) The circuit of the common source JFET amplifier shown in Figure Q5 has $V_{GS(OFF)} = -2.0V$ and $I_{DSS} = 1.4 \text{ mA}$. If you need this amplifier to be biased with $I_D = 0.7\text{mA}$, $V_{DD} = 20V$, and a voltage gain of 20dB, determine the value of R_S , and R_D ?

Assume that the FET Drain resistance $r_d \gg R_D$.

[4 Marks]

Hint: Use the expression in c ii) in your calculations.

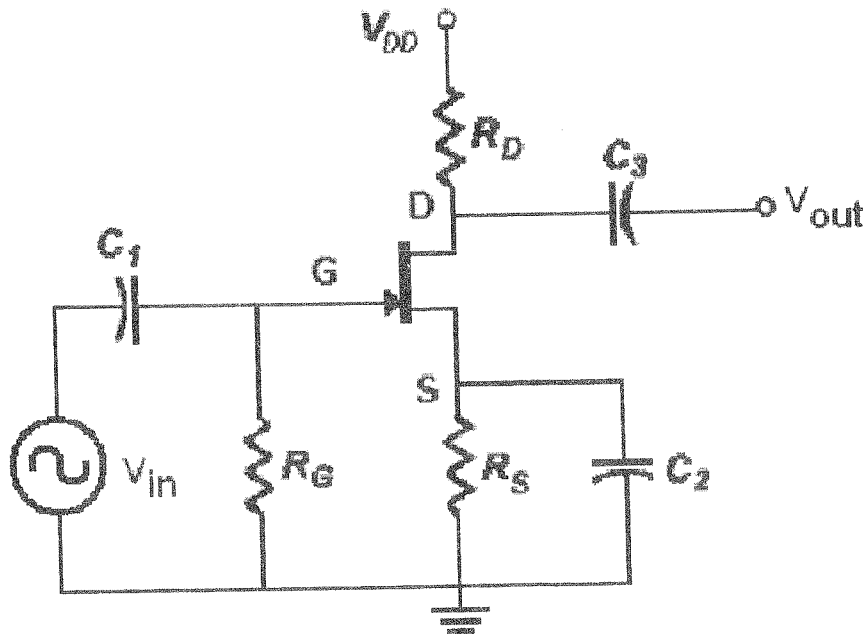

Figure Q5